

INSTRUCTION MANUAL (EN)
for
Mill HT600



mill®

Please read the instructions carefully before use. Take good care of this manual for later use.



Important safety information

You must obey common safety guidelines when using electrical products, especially in the presence of children.

WARNING! To avoid electric shock or damage due to the heat, always make sure the plug is pulled out and wait for the fan heater to cool down before it is moved or cleaned.

- The fan heater can only be used under supervision.
- Connect the fan to an outlet with the indicated voltage.
- Avoid using extension cords as this may generate heat in the cable which in turn creates a fire hazard.
- The fan should not be placed directly below a wall socket.
- The fan heater should never be used if the cable is damaged or destroyed. Have it replaced immediately by an authorized technician.
- The fan heater should always be disconnected when not in use. When you want to disconnect it, pull the plug and not the cable.
- The air input/output must never be covered. Keep a distance of at least 1 m in front and 50 cm behind the fan.
- Do not let animals or children touch or play with the fan heater. Be careful! The air outlet becomes hot during use.
- When not in use, the fan heater should be stored in a dry and cool place away from children.
- When moving and before cleaning or maintenance, unplug the cable from the mains and wait until the fan heater has completely cooled down.
- The fan heater should not be used near baths, showers or swimming pools.
- Do not use the fan heater, including the switches, sockets and outlet, with wet hands, as it may cause electric shock.
- The fan heater should never be covered, as this may cause overheating or fire.
- Do not use the fan heater in rooms with explosive gases or when using flammable solvents such as varnish or glue.
- Keep the fan heater clean. Prevent any object from entering the ventilation openings, as this may result in electric shock, fire or damage to the fan heater.
- When repaired, the fan heater should always be repaired by an authorized technician.

STORE THIS INSTRUCTION MANUAL FOR FUTURE USE!

Description of the heater

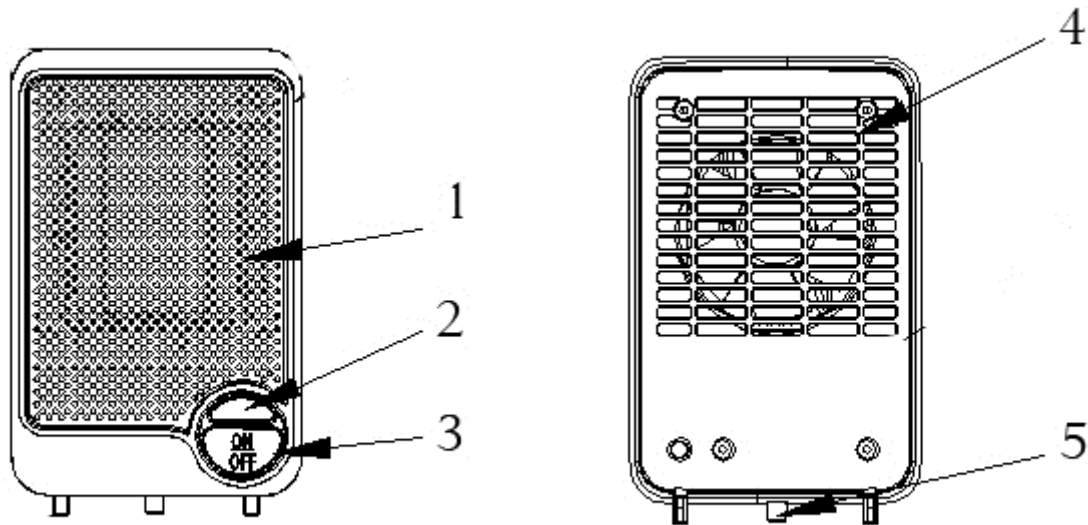

1. Air outlet
2. Signal light
3. On/off switch
4. Air intake
5. Overturn switch

Instruction Manual







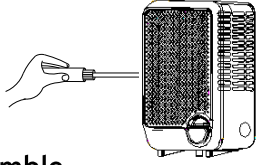

Using the heater

- 1) Place the heater on a flat surface. When you hear a click, you can hear the overturn fuse engage.
- 2) Connect the power cord to an outlet with the indicated voltage.
- 3) Press the ON/OFF button to set the heater.
 - a) The signal light will be on.
 - b) The fan will start.
 - c) Blowing hot air.
- 4) Press the ON/OFF button to turn off the heater. The signal light will go off.
- 5) If you lift the heater when it is connected, and the heater is turned on, the overturn fuse will cut off power and the heater will stop. The signal light will go off. When you put the heater down again, the overturn fuse will engage and the heater will start again. The signal light will be on.

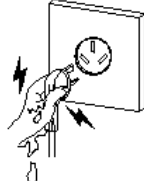
Safety instructions

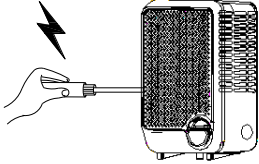
To avoid hazards or incorrect use of the device, please read the instructions carefully.

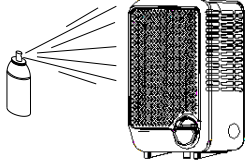
(For an explanation of symbols, see page 7.)

<p>At the slightest indication that something is wrong with the device, contact an authorized technician to repair it.</p>  <p>Do not disassemble</p> 	<p>Do not operate the device with wet hands. You can get electrocuted.</p>  <p>Electric shock</p>  <p>Do not touch!</p> 
<p>Do not insert metal objects or other sharp objects into the device.</p>  <p>Electric shock Important</p>  	<p>Do not use open flame or other flammable sprays near the device.</p>  <p>Forbidden</p> 

During cleaning, the device must always be switched off and the power cord must be removed from the wall outlet.

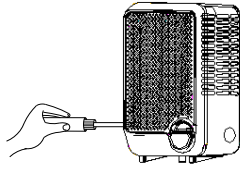

Do not disassemble



Do not unplug by pulling the power cord.

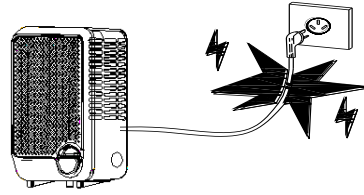

Electric shock Forbidden



Make sure that the cord is undamaged and the plug is properly plugged in the socket.

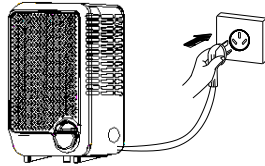

Electric shock Important



If the heater produces weird smell or there come strange sounds from the device, stop the heater and remove the plug.

Important

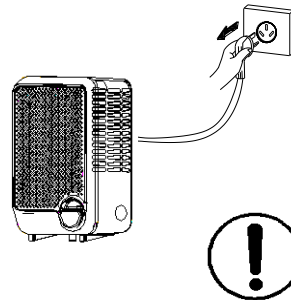

If the cable is destroyed, the device must not be used. Contact the service department.

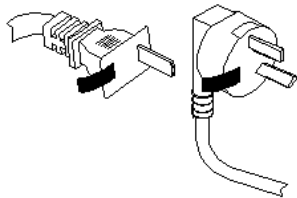

Electric shock Important





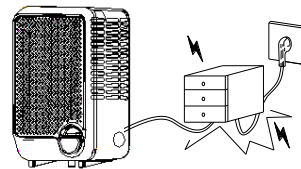





The cord must not be curled. Do not place heavy objects on the cord.

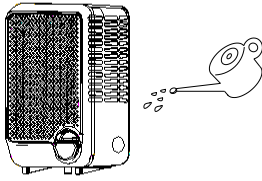

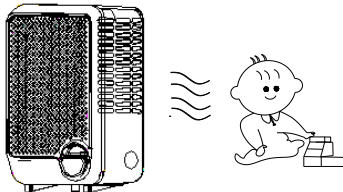

Electric shock

Forbidden



<p>The fan heater must not be rinsed under water.</p>  <p>Electric shock Important</p> 	<p>Never let the fan blow directly at children.</p>  <p>Forbidden</p> 
<p>If the device is left unused for a long time, turn it off and unplug it. Never allow children or people with impaired functions to use the heater.</p> <p>Important</p> 	<p>Use power outlet that meets the standard (10 A / 230 V). Make sure that the power supply is stable (AC 220–240 V~ 50 Hz). If the device is moved, check if the power supply is correct.</p> <p>Important</p> 
<p>Never use the device near water. Never use the appliance directly below power outlet. Never use the appliance pressed towards the wall, curtain or other flammable object, because it can cause fire.</p> <p>Forbidden</p> 	<p>Avoid overheating. Never place any objects over the fan heater. Never insert any objects into the device.</p> <p>Forbidden</p> 

Explanation of symbols in the safety instructions:

 <p>WARNING</p>	<p>An action which can result in damage to the fan heater and/or persons.</p>
 <p>FORBIDDEN</p>	<p>An action which is <u>strictly</u> prohibited.</p>
 <p>MUST BE FOLLOWED</p>	<p>An action that must be performed exactly as described.</p>

Maintenance

1. Before cleaning, always unplug the heater and leave it to cool.
2. Wipe the heater regularly with a damp cloth and dry the surface before turning on the heater again.
3. The heater must be cleaned at least once a month during the heating season.

CAUTION! The heater should never be immersed in water.

Avoid using detergents to clean the heater.

Never let any water get inside the heater; this can be hazardous.

4. Dust etc. should be removed with a soft cloth.
5. The heater should be stored in a dry and clean place.
6. If the heater stops working, do not attempt to repair it yourself because it can cause a fire hazard and/or electric shock.

Technical specification

Model no.	HT600
Voltage	220–240 V~
Frequency	50 Hz
Current	600 W
Noise level	≤50 dB
Dimensions	185*120*95 (mm)

Warranty

The warranty is valid for 2 years. The heater will be repaired or replaced during this time should any malfunction occur. The warranty applies if the heater is used according to these instructions and the customer can present a purchase receipt. If the heater malfunctions in any way, please contact the store where it was purchased or the importer.

Waste disposal

In accordance with the European Directive regarding electronic appliances (Waste Electrical and Electronic Equipment – (WEEE)), please return any electrical equipment that is no longer needed.

This symbol indicates that the appliance cannot be handled as normal household waste, but should be delivered to a designated collection point for recycling electronics and electrical appliances.



Mill International AS

Grini Næringspark 12

1361 Østera

Tel.: +47 22 13 32 00

www.millheat.com