



Mill Invisible & Glass WiFi panel heater Illustrations **mill**[®]



1. DESCRIPTION OF THE HEATER

2. ASSEMBLY

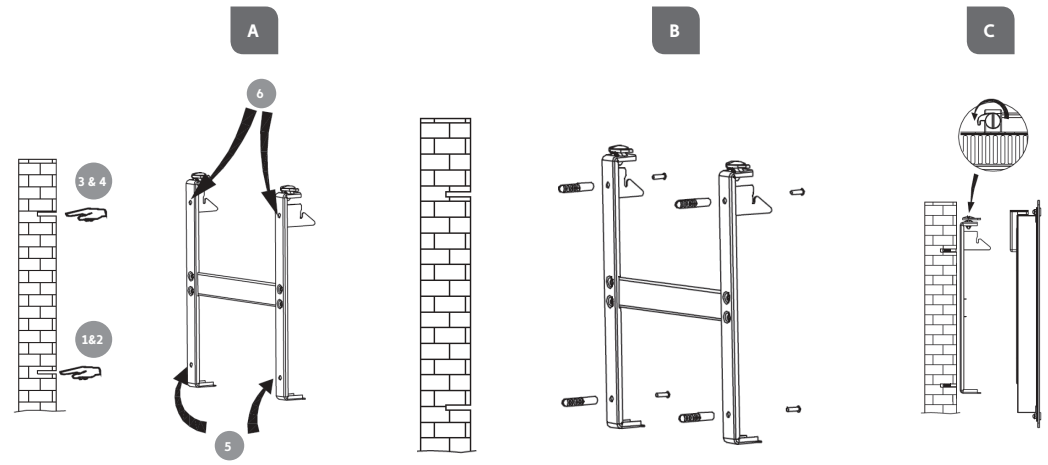
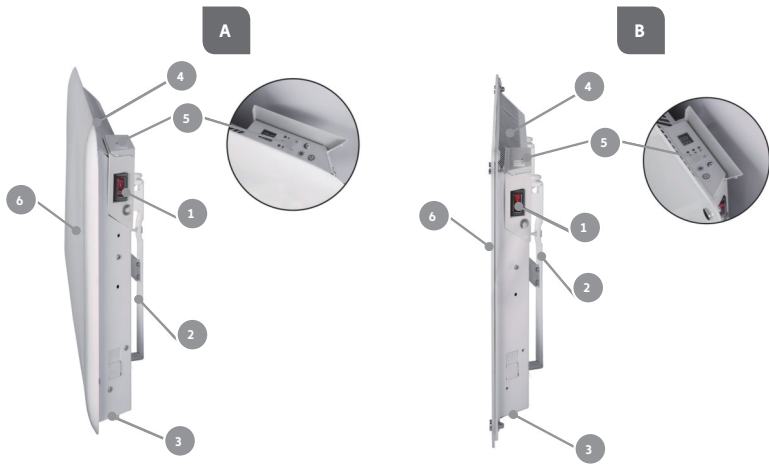

3. POWER INDICATOR

4. TEMPERATURE CALIBRATION

5. RESETTING THE HEATER

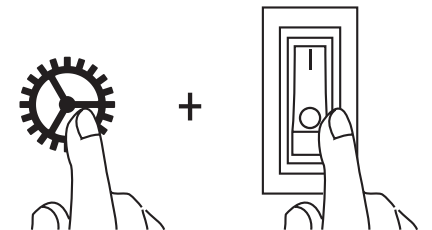
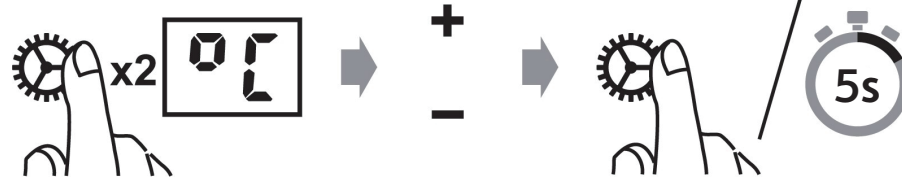
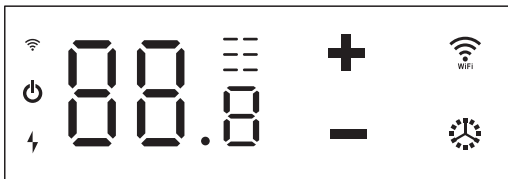



6. CONTROL PANEL

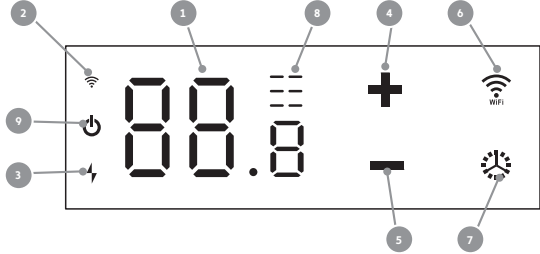

7. SET DESIRED TEMPERATURE WITHOUT WIFI CONNECTION



8. ACTIVATING WIFI



9. DEACTIVATING WIFI

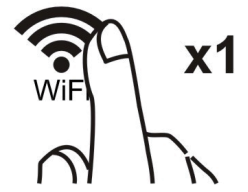

10. RECONNECTING WIFI

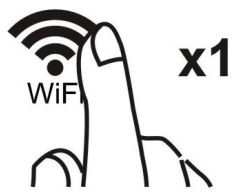

11. DELETE WIFI SETTINGS

