

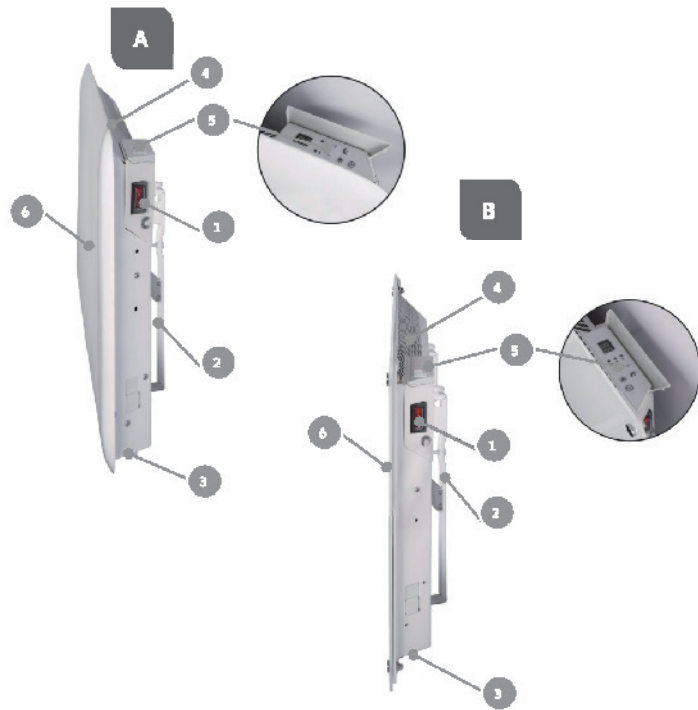

Mill Invisible & Glass panel heater illustrations

1. DESCRIPTION OF THE HEATER



2. ASSEMBLY

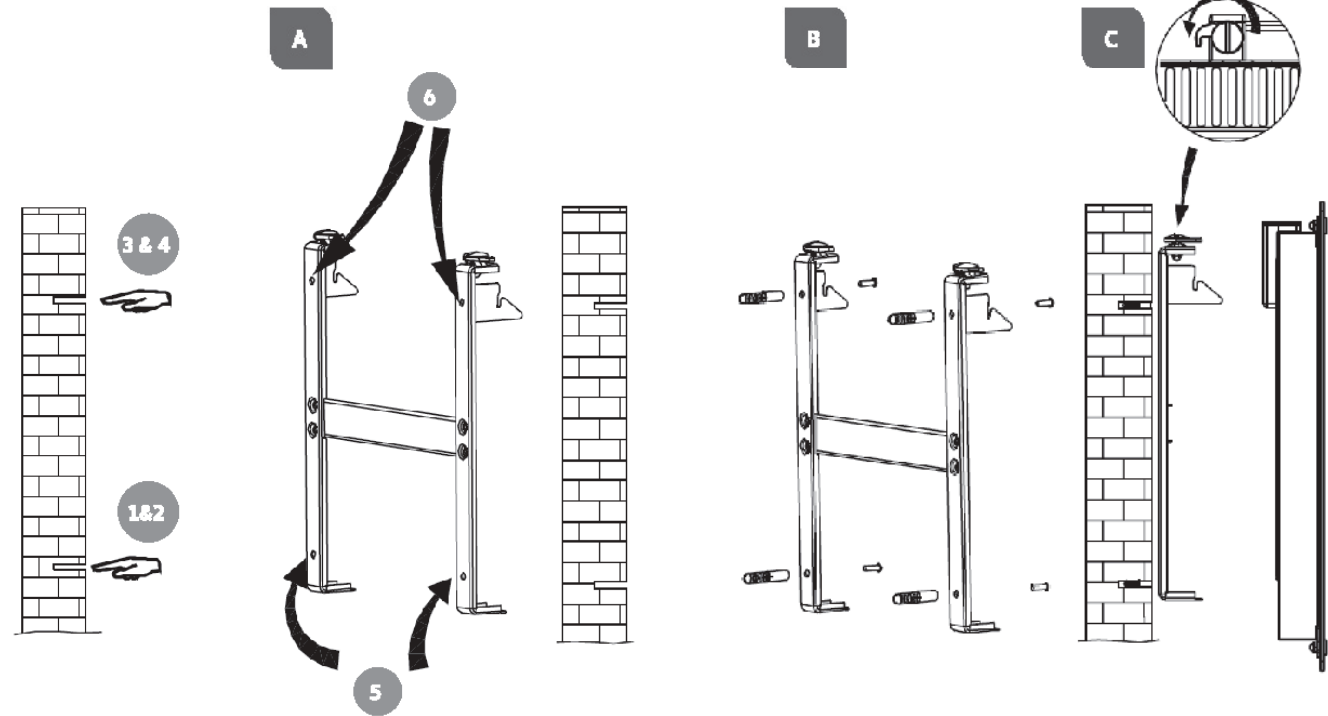

3. TEMPERATURE CALIBRATION



4. RESETTING THE HEATER

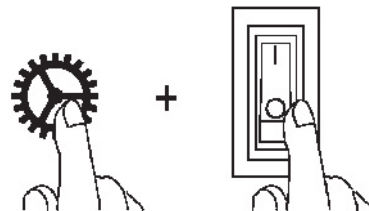

5. CONTROL PANEL ELECTRONIC THERMOSTAT

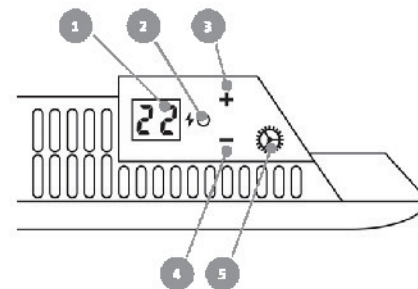

6. POWER INDICATOR ELECTRONIC THERMOSTAT

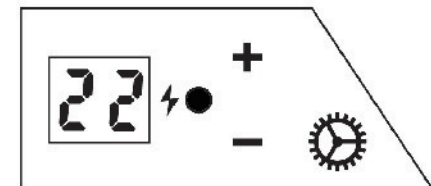

7. SET DESIRED TEMPERATURE



8. CONTROL PANEL DAY/NIGHT THERMOSTAT

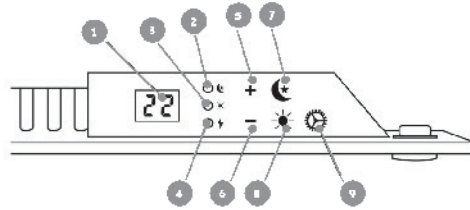

9. POWER INDICATOR DAY/NIGHT THERMOSTAT

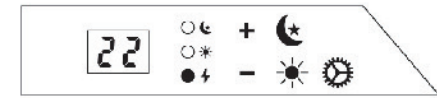

10. HOW TO ACTIVATE DAYTIME SETBACK

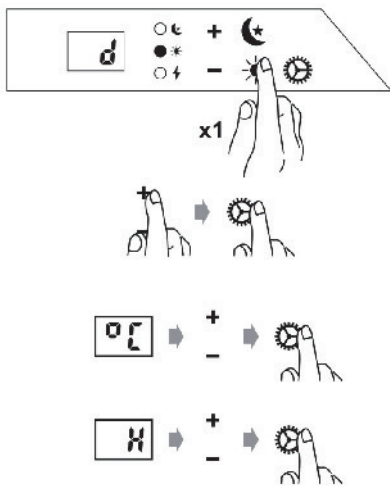

11. HOW TO ACTIVATE NIGHTTIME SETBACK

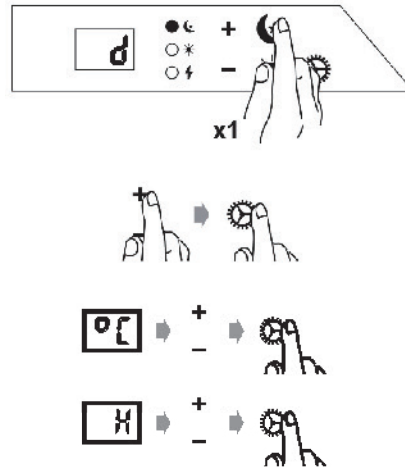

12. CHANGE SETBACK TEMPERATURE — DAYTIME



13. CHANGE SETBACK TEMPERATURE — NIGHTTIME



14. CHANGE NUMBER OF HOURS — DAYTIME



15. CHANGE NUMBER OF HOURS — NIGHTTIME

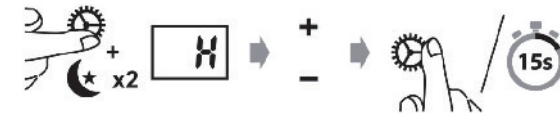

16. CANCEL (SKIP) SETBACK PERIOD

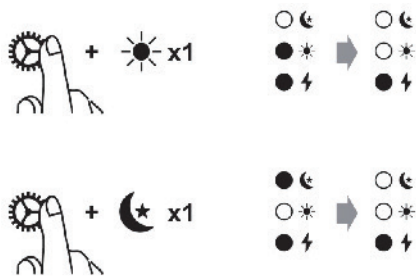

17. DELETE A SETBACK PROGRAM

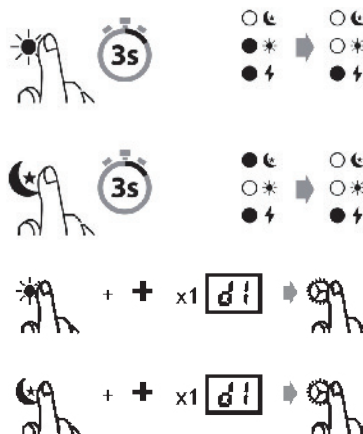

18. HOW TO ACTIVATE ADVANCED MODE

